

**AVE mbH**

**Digitally Controlled Line Array**  
*Ascolto*<sup>®</sup>

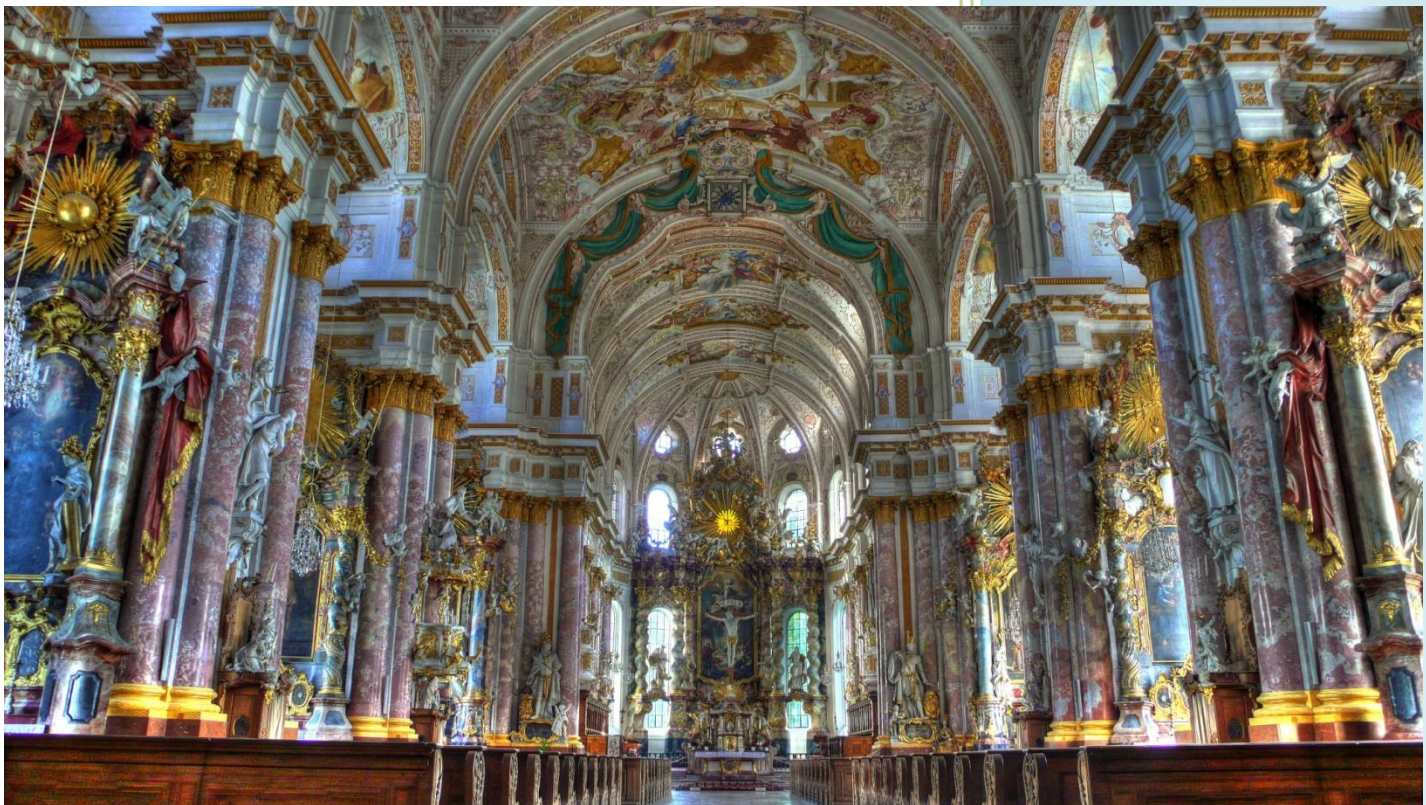

**A.V.E. mbH**

**Audio Vertriebs-Entwicklungsgesellschaft**

**Germany**

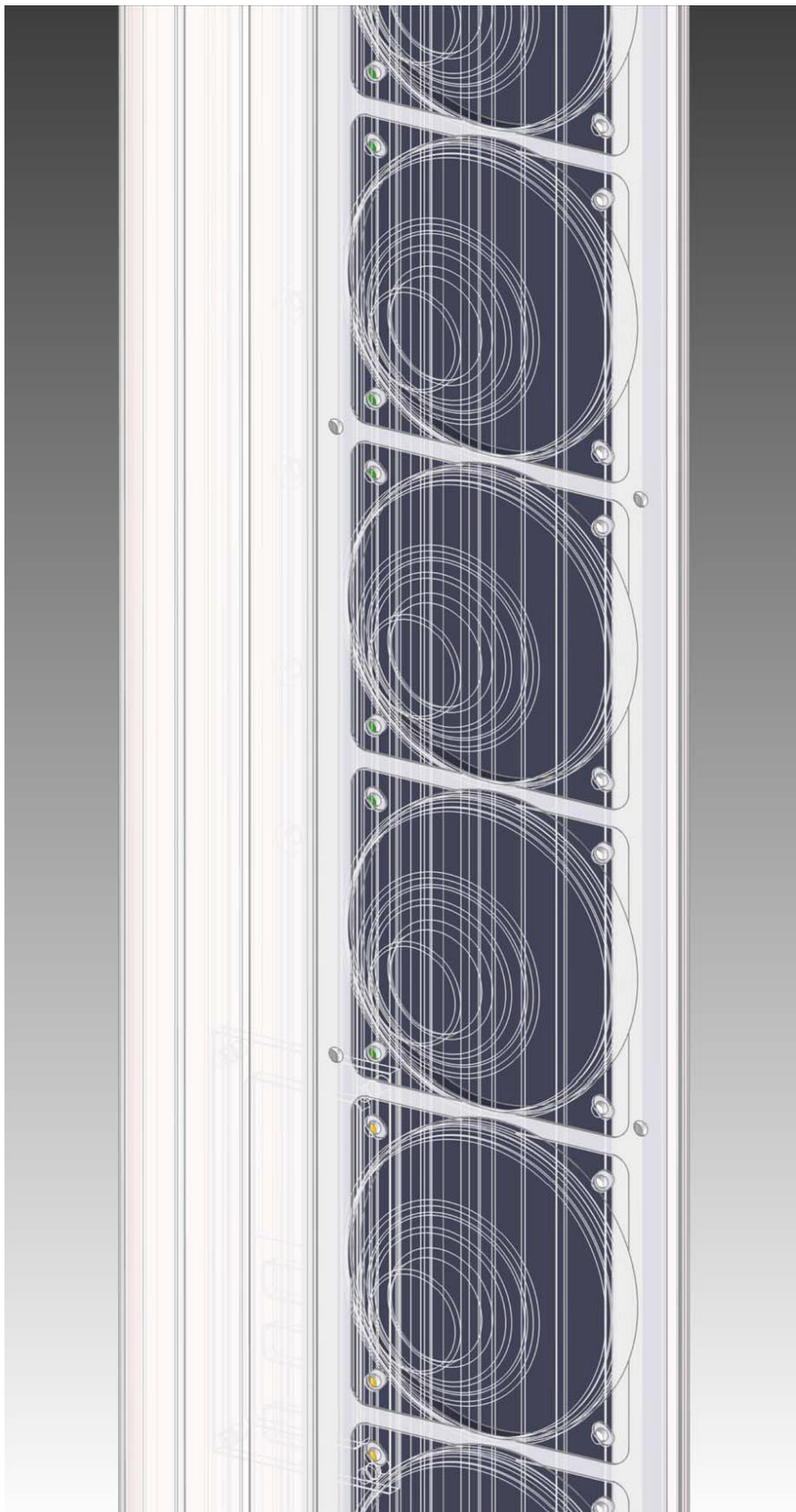

**Digitally  
Controlled  
Line Array**  
*Ascolto*<sup>®</sup>

**LH4025  
Datasheet**

# Table of Contents

1. **Acoustic Specifications**
2. **Electrical Specifications**
3. **General Specifications**
4. **Vertical Beam Pattern**
5. **Attenuation Balloon**
6. **Horizontal Polar Responses**
7. **Vertical Polar Responses**
8. **Schematic Blocks**
9. **Mechanical Details**

## 1.0 – Acoustic Specifications

### Frequency Bandwidth

120 Hz to 20 kHz ( $\pm 3$  dB)

### SPL

#### Nominal/Peak

104 dB / 107 dB (A-Weighted at 10 m)

101 dB / 104 dB (A-Weighted at 20 m)

99 dB / 102 dB (A-Weighted at 30 m)

98 dB / 101 dB (A-Weighted at 40 m)

### Coverage

Horizontal (fixed) 155° (-6 dB average 1 kHz to 4 kHz)

Vertical (adjustable) Tilting Angle: -60° to 60°

Opening Angle: 10° to 40°

Typical Throw 30 m

Maximum Throw 35 m

### Dynamic Range

102 dB (f=1 kHz, AES17 filter)

### Transducers

Number 40

Diameter 2.5" Full Range

Magnet Neodymium

Rated Power 15 W (with pink noise, 6 dB crest factor)

Musical Power 30 W

Sensitivity 1 W/1 m 85.2 dB

## 2.0 – Electrical Specifications

### Audio Input 1: Line 0 dBu

|                     |                   |
|---------------------|-------------------|
| Input Level Nominal | 0 dBu (2.19 Vpp)  |
| Input Level Maximum | 10 dBu (6.92 Vpp) |
| Type                | Balanced          |
| Impedance           | 20 kΩ at 1 kHz    |

### Audio Input 2: 100 V (Distributed Speaker System)

|                     |                           |
|---------------------|---------------------------|
| Input Level Nominal | 39.2 dBu (200 Vpp)        |
| Type                | Balanced with Transformer |
| Impedance           | 20 kΩ at 1 kHz            |

### Power Amplifier

|                         |  |
|-------------------------|--|
| Type                    | PWM (Class D)  |
| Output Power            | 40 × 25 W <sub>rms</sub> (8 Ω)   |
| Power Efficiency        | 86%  |
| THD+N                   | 0.07% at 10 W <sub>rms/channel</sub>                                     |
| Output Integrated Noise | 65 μV (typical) measured from 20 Hz to 22 kHz                            |
| Input Signal            | Balanced   |
| Channel Protections     | Thermal Shutdown (T <sub>junction</sub> > 150°C)<br>Output Short Circuit |

### DSP Module

|                |   |
|----------------|---|
| DSP Processors | 48 bit Fixed Point DSP<br>76-bit Internal Accumulator |
|----------------|---|



|                   |  |
|-------------------|--|
|                   | 145 MHz  |
| Sample Rate       | 48 kHz   |
| A/D Conversion    | Resolution: 24 bit Linear PCM<br>Conversion: 1-bit delta-sigma 256x<br>Sample Rate: 48 kHz<br>SNR: 102 dB (A-Weighted)   |
| D/A Conversion    | Resolution: 24 bit Linear PCM<br>Conversion: upsampling 128x<br>Sample Rate: 48 kHz<br>SNR: 105 dB (A-Weighted)  |
| Signal Processing | Beam Forming Filtering<br>Input Equalization (10 Biquad)<br>Volume (-120 dB <sub>FS</sub> to 0 dB <sub>FS</sub> )<br>Delay (0 m to 30 m, step 0.1 m)<br>Dynamic Compressor 2-Bands<br>Input Signal Activity Detector |

### Control Module

|                      |   |
|----------------------|---|
| Processor            | 32 bit ARM-Cortex M3<br>RISC<br>50 MHz  |
| Network Interface    | RS485, Half Duplex, 115200 baud/s<br>120 Ω Parallel Termination (recommended for long distance)                                     |
| Processor Activities | DSP Firmware Booting<br>DSP Status Monitoring<br>PWM Power Amplifier Functions Controlling<br>PWM Power Amplifier Status Monitoring |

Audio Input Channel Functions Controlling

Auto Stand-By Controlling

RS485 Communication

Infrared Communication

Panel LEDs Controlling

Firmware Updating

## Connectors

|                         |  |
|-------------------------|--|
| Audio Inputs Connector  | 3-pole, 3.81 mm-pitch  |
| Audio Inputs Pinout     | pin 1: hot signal (+)<br>pin 2: cold signal (-)<br>pin 3: earth (chassis ground) |
| RS485 Network Connector | 3-pole, 3.81 mm-pitch  |
| RS485 Network Pinout    | pin 1: data +<br>pin 2: data -<br>pin 3: digital ground                          |
| Mains Connector         | IEC 60320 C14 three poles  |

## PSU Module

|                            |   |
|----------------------------|---|
| AC Range                   | 90 VAC to 264 VAC (Universal Input)                 |
| Input Frequency            | 47 Hz to 67 Hz                                      |
| Efficiency                 | 91% typ at 230 VAC                                  |
| Input Current at Full Load | 8.0 A typ at 115 VAC<br>4.0 A typ at 230 VAC        |
| Power Consumption          | Continuous: 790 VA<br>Idle: 24 VA<br>Stand-By: 4 VA |

|            |   |
|------------|---|
| Protection | Thermal Protection<br>Output Current Limiting<br>Under-Voltage Lock Out |
| Main Fuse  | 1 x 6.3 A (slow blow)   |

### 3.0 – General Specifications

#### Mechanical

|                |                                     |
|----------------|-------------------------------------|
| Height         | 3190 mm                             |
| Width          | 90 mm                               |
| Depth          | 100 mm                              |
| Weight         | 14.20 Kg (31.30 lbs)                |
| Cabinet        | Powder Coated<br>Aluminum Extrusion |
| Colour         | RAL 9010                            |
| Special colour | available for an additional charge  |

#### Temperature Range

0°C to 40°C (32°F to 102°F)

#### Certificates

CE



## 4.0 – Vertical Beam Pattern

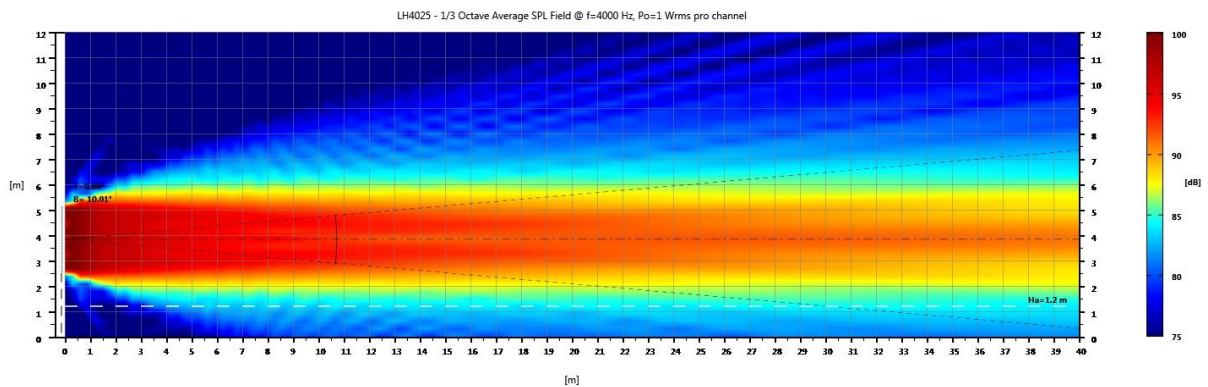
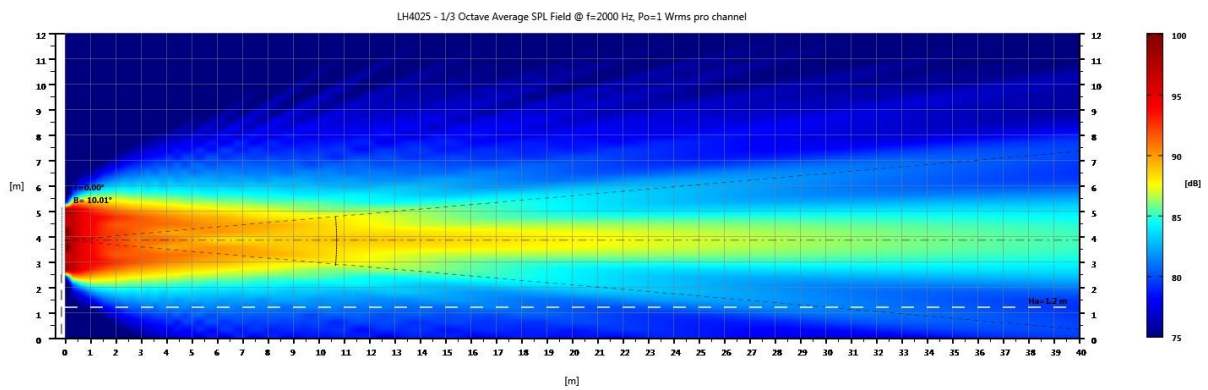
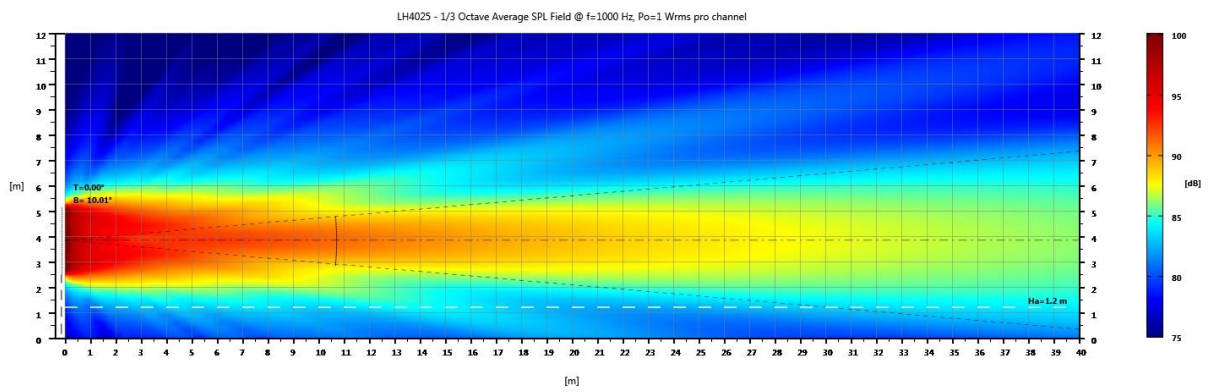
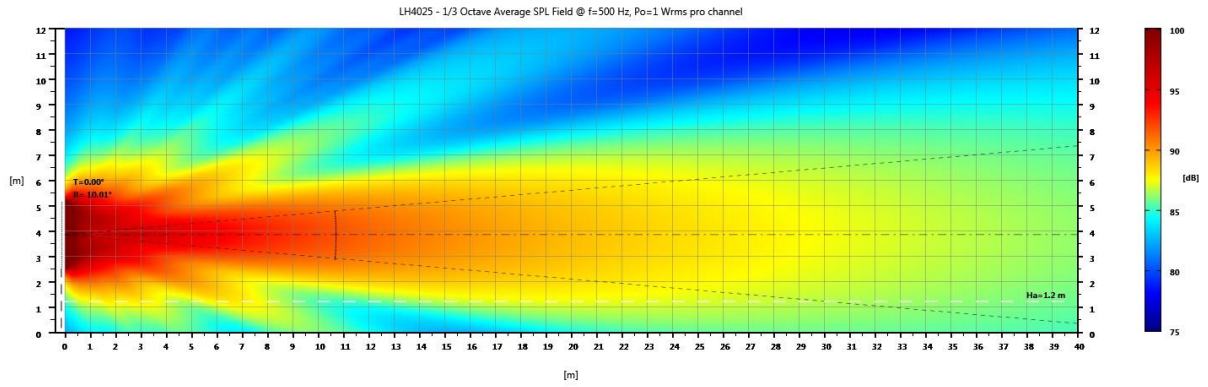

## 5.0 - Attenuation Balloon

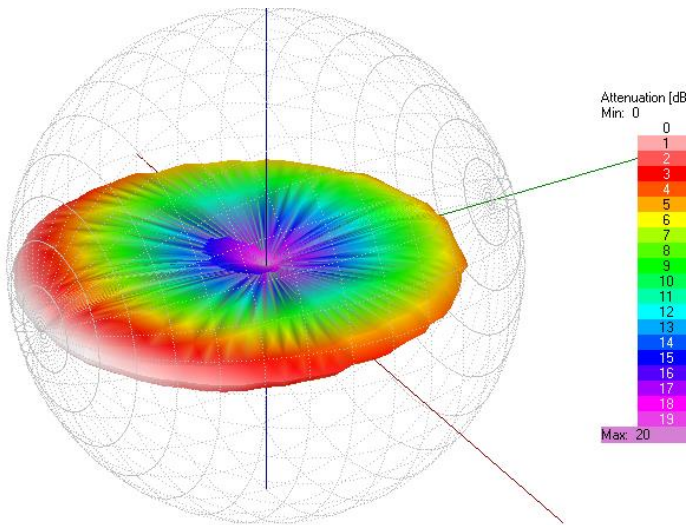

LH4025 – Attenuation Balloon – Freq = 500 Hz

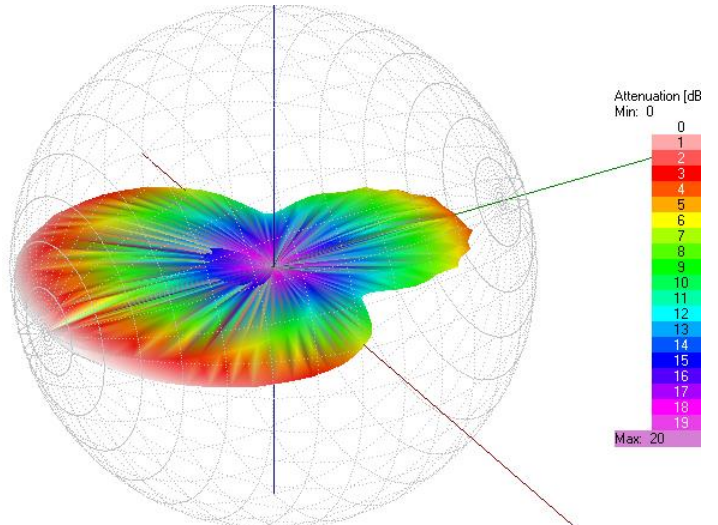

LH4025 – Attenuation Balloon – Freq = 1000 Hz

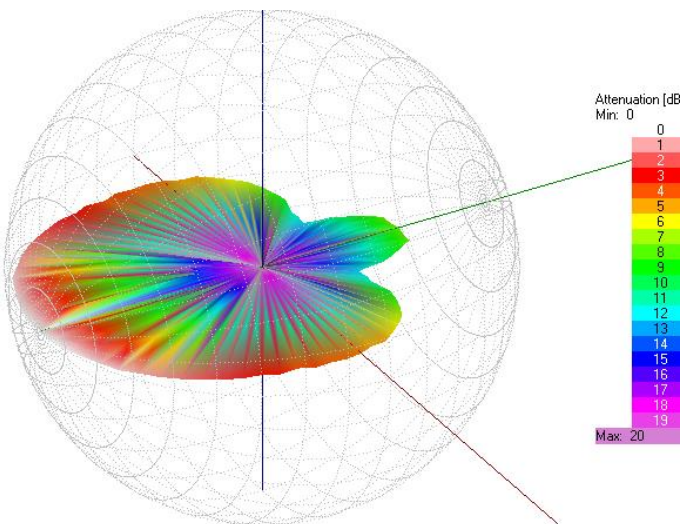

LH4025 – Attenuation Balloon – Freq = 2000 Hz

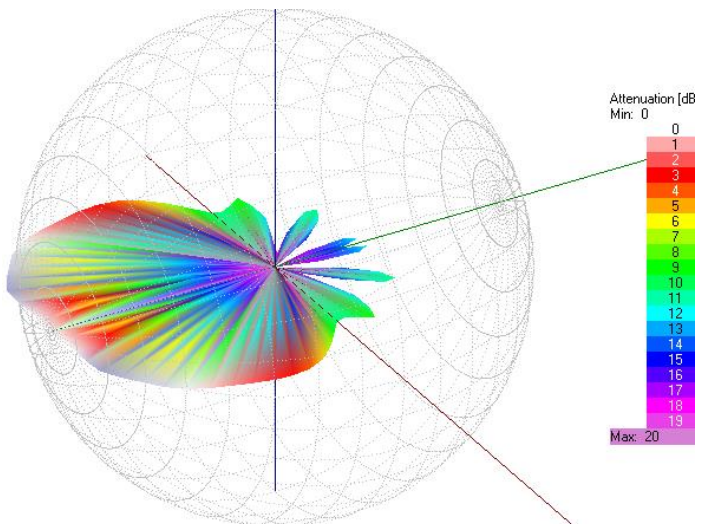

LH4025 – Attenuation Balloon – Freq = 4000 Hz

## 6.0 - Horizontal Polar Responses

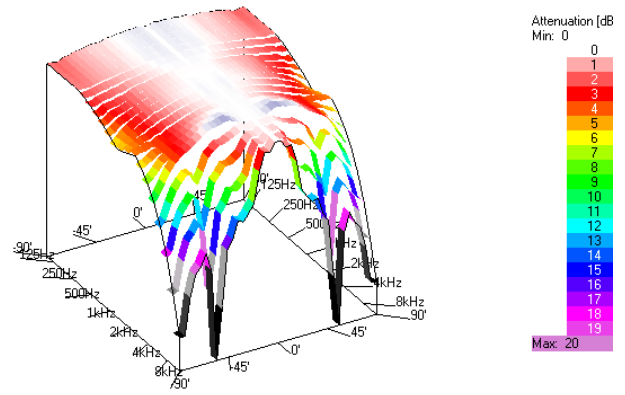
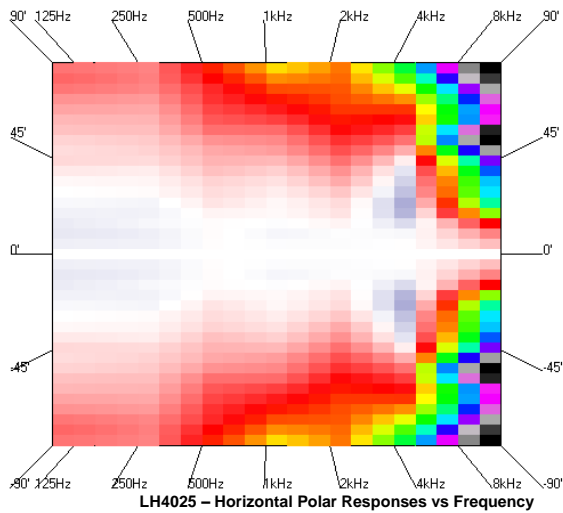

## 7.0 - Vertical Polar Responses

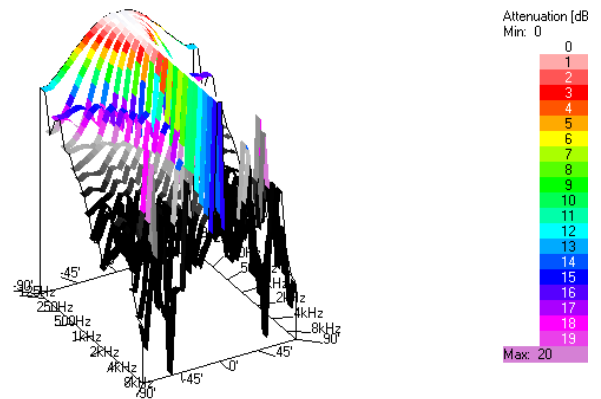
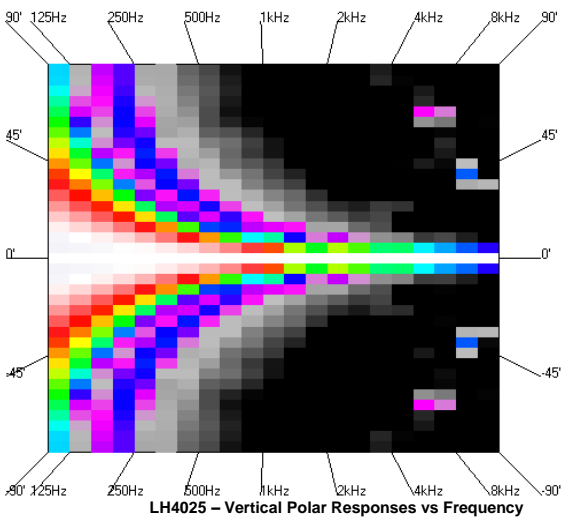



## 8.0 – Schematic Blocks

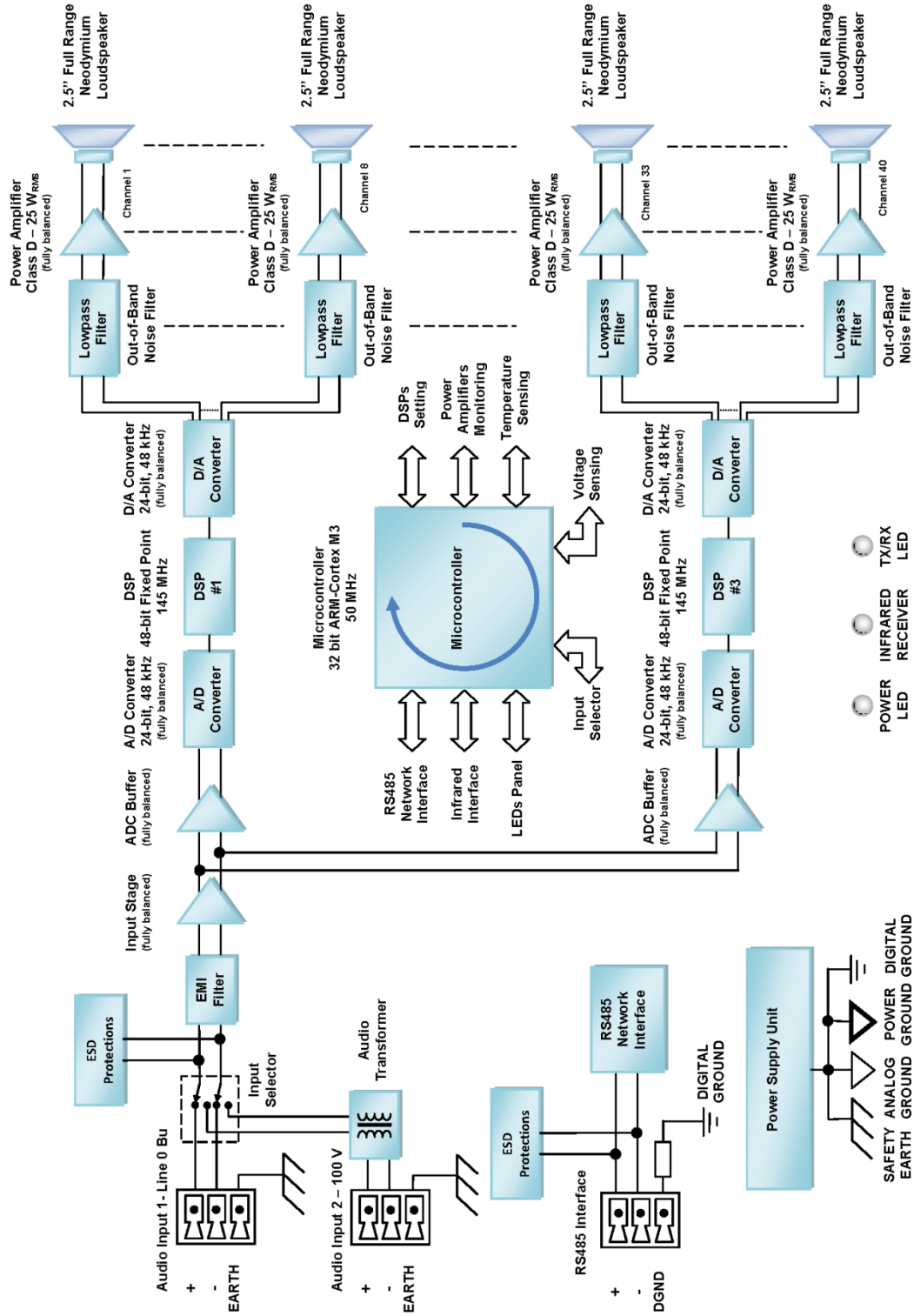

## 9.0 - Mechanicals Dimensions

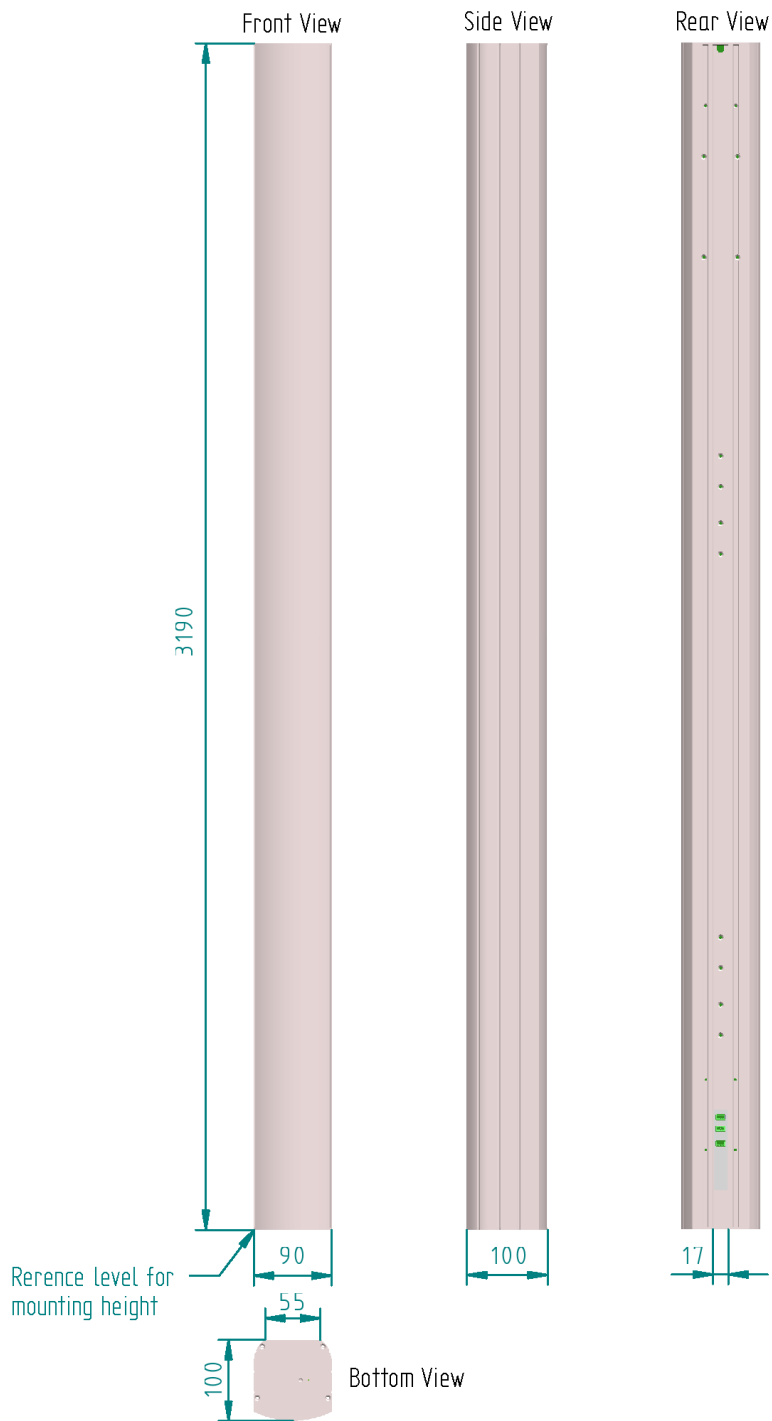

Figures not drawn to scale

## Notice

ALL AVE mbH DESIGN SPECIFICATIONS, FILES, DRAWINGS, TABLES, LISTS, AND OTHER DOCUMENTS ARE BEING PROVIDED "AS IS."

AVE mbH MAKES NO WARRANTIES, EXPRESSED, IMPLIED, STATUTORY, OR OTHERWISE WITH RESPECT TO THE MATERIALS, AND EXPRESSLY DISCLAIMS ALL IMPLIED WARRANTIES OF NONINFRINGEMENT, MERCHANTABILITY, AND FITNESS FOR A PARTICULAR PURPOSE.

Information furnished is believed to be accurate and reliable. However, AVE mbH assumes no responsibility for the consequences of use of such information or for any infringement of patents or other rights of third parties that may result from its use. No license is granted by implication or otherwise under any patent or patent rights of AVE mbH. Specifications mentioned in this publication are subject to change without notice. This publication supersedes and replaces all information previously supplied. AVE mbH products are not authorized for use as critical components in life support devices or systems without express written approval of AVE mbH Corporation.

## Trademarks

AVE mbH, "Ascolto" and the AVE logo are trademarks or registered trademarks of AVE mbH in Germany and other countries. Other company and product names may be trademarks of the respective companies with which they are associated.

## Copyright

© 2014 AVE mbH. All rights reserved.



**AVE mbH**  
**Gustav-Rau-Straße, 6**  
**74321 - Bietigheim-Bissingen**  
**Germany**

**Telefon: +49 (0) 7142-78879-10**

**Fax: +49 (0) 7142-78879-18**

[www.ave-stuttgart.com](http://www.ave-stuttgart.com)

[info@ave-stuttgart.de](mailto:info@ave-stuttgart.de)

